

Nickel Plated Piloted Flanges



With Black Oxide Bearing Inserts-BUCNPFCS

• B-type Seals

• Overview of corrosion resistant products – pg. 52

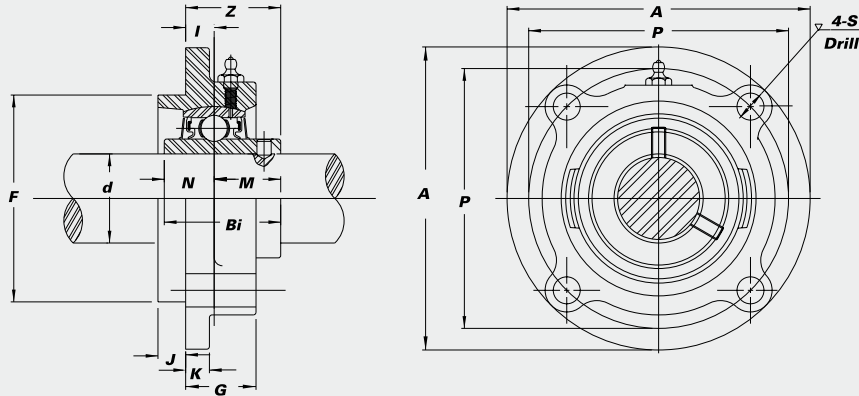

CORROSION RESISTANT

Unit No.	Shaft Dia.		Dimensions (in.) (mm)											Bolt Used (in.)	Bearing No.	Housing No.	Weight (lbs.)			
	d (in.)	d (mm)	A	P	S	J	K	G	F	I	Z	Bi	N					M		
BUCNPFCS 206-18	1 1/8																	BUC 206-18		
206		30	4 3/8	3 5/8	3 3/8	1 5/64	3 3/8	1 5/16	3.000	2 5/64	1 9/32	1.5000	0.6260	0.8740	5/16	206	NPFC X05	2.6		
206-19	1 3/16		111	92	9.5	6.0	9.5	24.0	76.2	10	32.2	38.1	15.9	22.2		206-19				
206-20	1 1/4 S															206-20				
BUCNPFCS 207-20	1 1/4																	BUC 207-20		
207-22	1 3/8		5	4 1/8	1 5/32	3 3/8	3 3/8	7 3/8	3.375	5 1/16	1 5/16	1.6890	0.6890	1.0000	3/8	207-22	NPFC X06	3.3		
207		35	127	104.8	12.0	9.5	9.5	22.5	85.7	8	33.4	42.9	17.5	25.4		207				
207-23	1 7/16															207-23				
BUCNPFCS 208-24	1 1/2																	BUC 208-24		
208		40	5 1/4	4 3/8	1 5/32	7 1/16	7 1/16	1 1/32	3.625	2 3/64	1 11/32	1.9370	0.7480	1.1890	3/8	208	NPFC X07	4.2		
BUCNPFCS 209-26	1 5/8																	BUC 209-26		
209-27	1 11/16		5 1/4	4 3/8*	1 5/32	7 1/16	7 1/16	1 1/32	3.625*	2 3/64	1 11/32	1.9370	0.7480	1.1890	3/8	209-27	NPFC X08	4.4		
209-28	1 3/4		133	111	12.0	11.0	11.0	26.0	92.1	9	39.2	49.2	19.0	30.2		209-28				
209		45														209				
BUCNPFCS 210-30	1 7/8																	BUC 210-30		
210-31	1 15/16		6 3/32	5 1/8	3 5/64	1 5/32	7 1/16	1	4.250	5 1/16	1 19/32	2.0315	0.7480	1.2835	7/16	210-31	NPFC X09	5.7		
210		50	155	130	14.0	12.0	11.0	25.0	108.0	8	40.6	51.6	19.0	32.6		210				
210-32	2 S															210-32				
BUCNPFCS 211-32	2																	BUC 211-32		
211		55	6 3/8	5 3/8	3 5/64	5 3/8	7 1/16	1	4.500	9 3/32	1 19/32	2.1890	0.8740	1.3150	7/16	211	NPFC X10	7.0		
211-35	2 3/16		162	136.5	14.0	16.0	11.0	25.0	114.3	7	40.4	55.6	22.2	33.4		211-35				
BUCNPFCS 212-36	2 1/4																	BUC 212-36		
212		60	7 3/32	6	5 3/8	5 5/64	1 1/2	1 1/32	5.000	5 3/32	1 23/32	2.5630	1.0000	1.5630	1/2	212	NPFC X11	9.5		
212-39	2 7/16		180	152.4	16.0	22.0	13.0	26.0	127.0	4	43.7	65.1	25.4	39.7		212-39				
BUCNPFCS 213-40	2 1/2																	BUC 213-40		
			7 5/8	6 1/2	5 3/8	2 5/32	9 1/16	1 5/16	5.500	7 1/16	2	2.5630	1.0000	1.5630	1/2	213-40	NPFC X12	11.7		

* Also available in FCF(209) style housing where P=5 1/8", F=4.250. See pg. 37 for other details.